

# Impacto de pequenas variáveis de processo na produtividade de uma indústria de grande porte

Rafael C. D. Costa, CEO

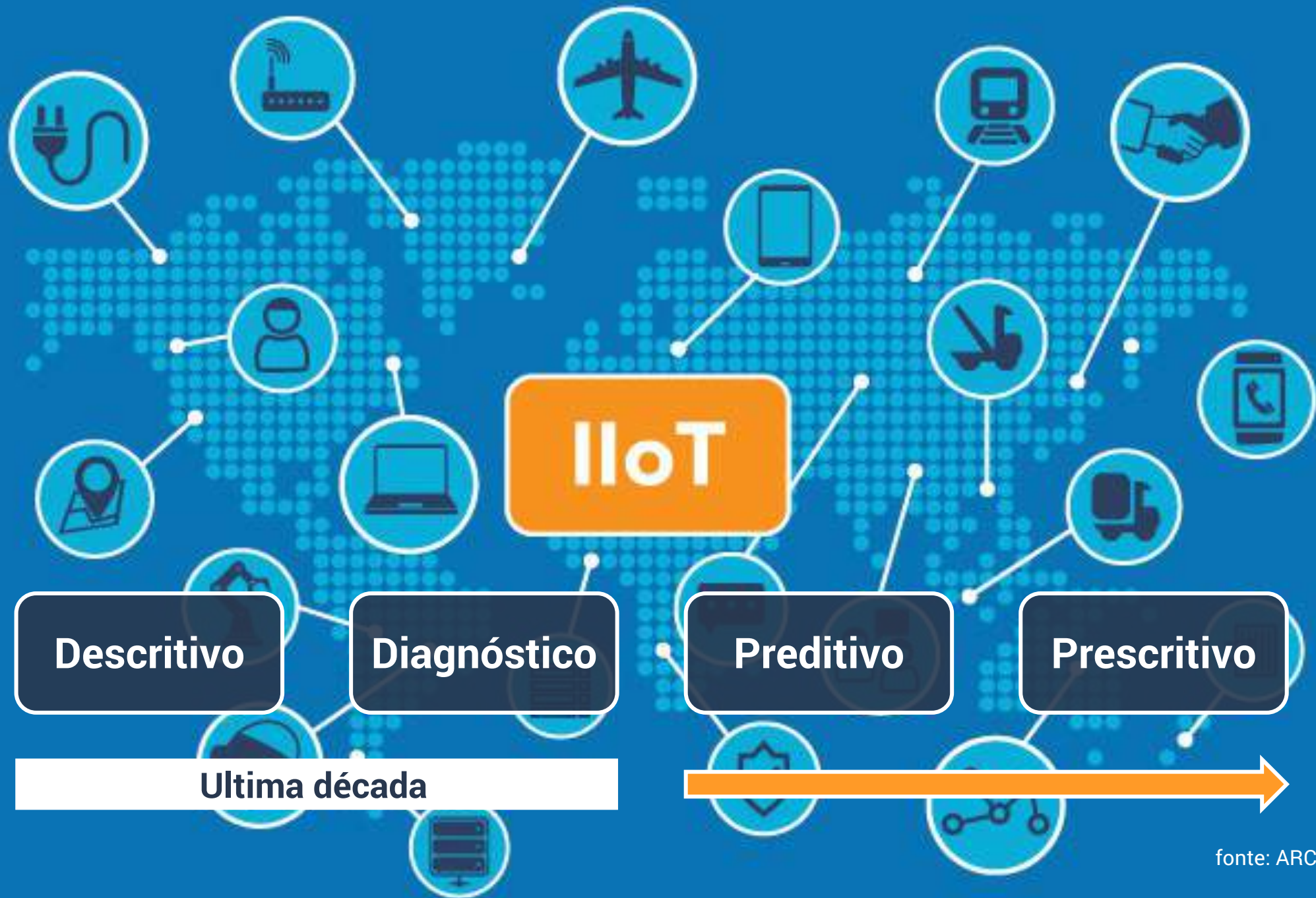

**VIRTURIAN**



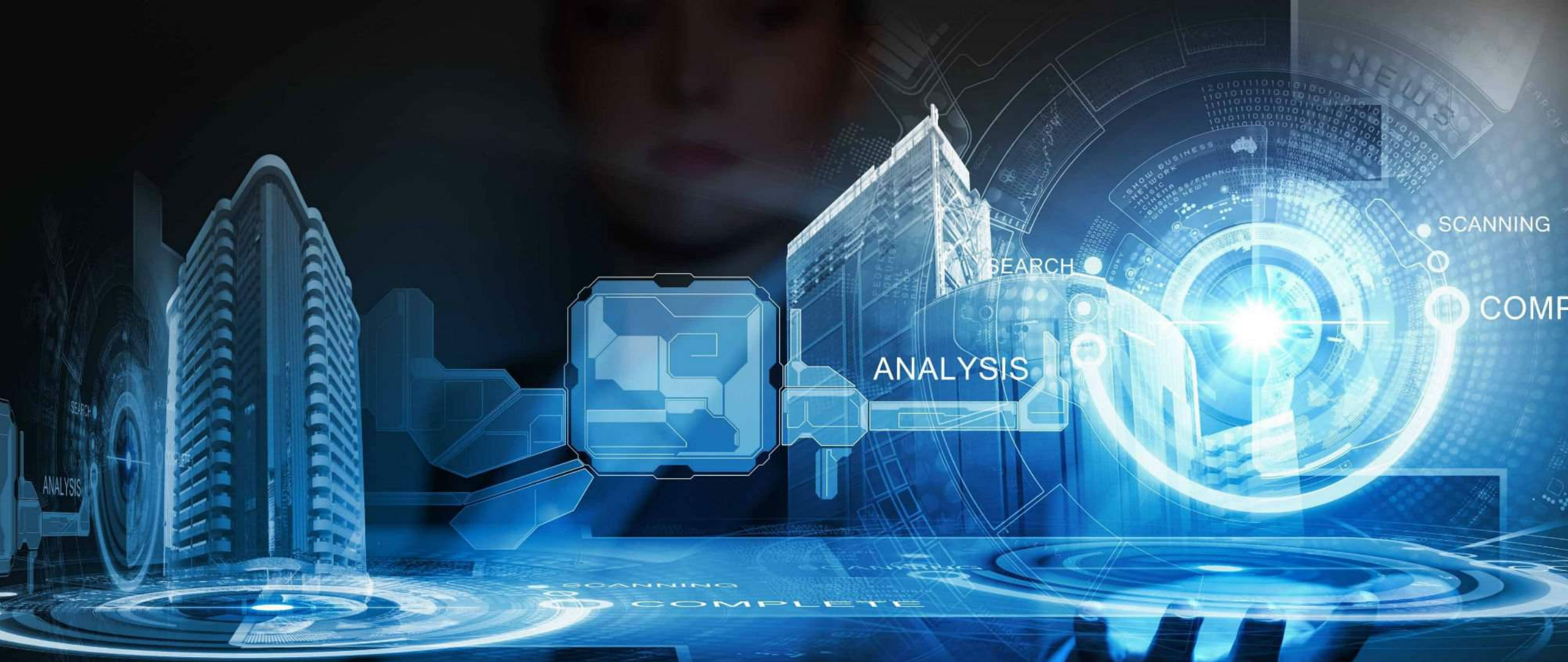

**Manutenção  
Preditiva**

**PLM**

**Desempenho**



OEM

Machine  
Learning

Ciber-física



**ambeev**

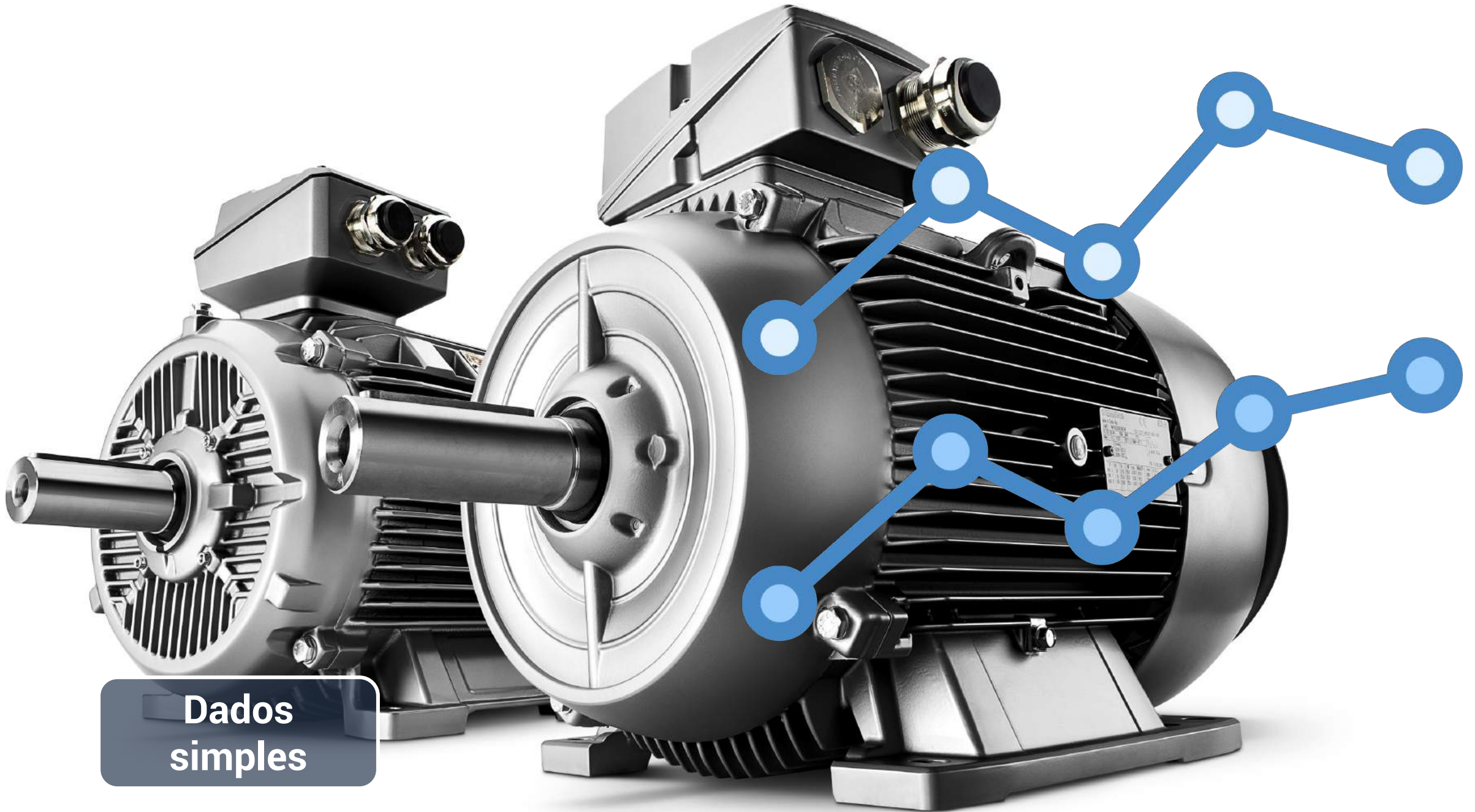

**Dados  
simples**



# BIG DATA

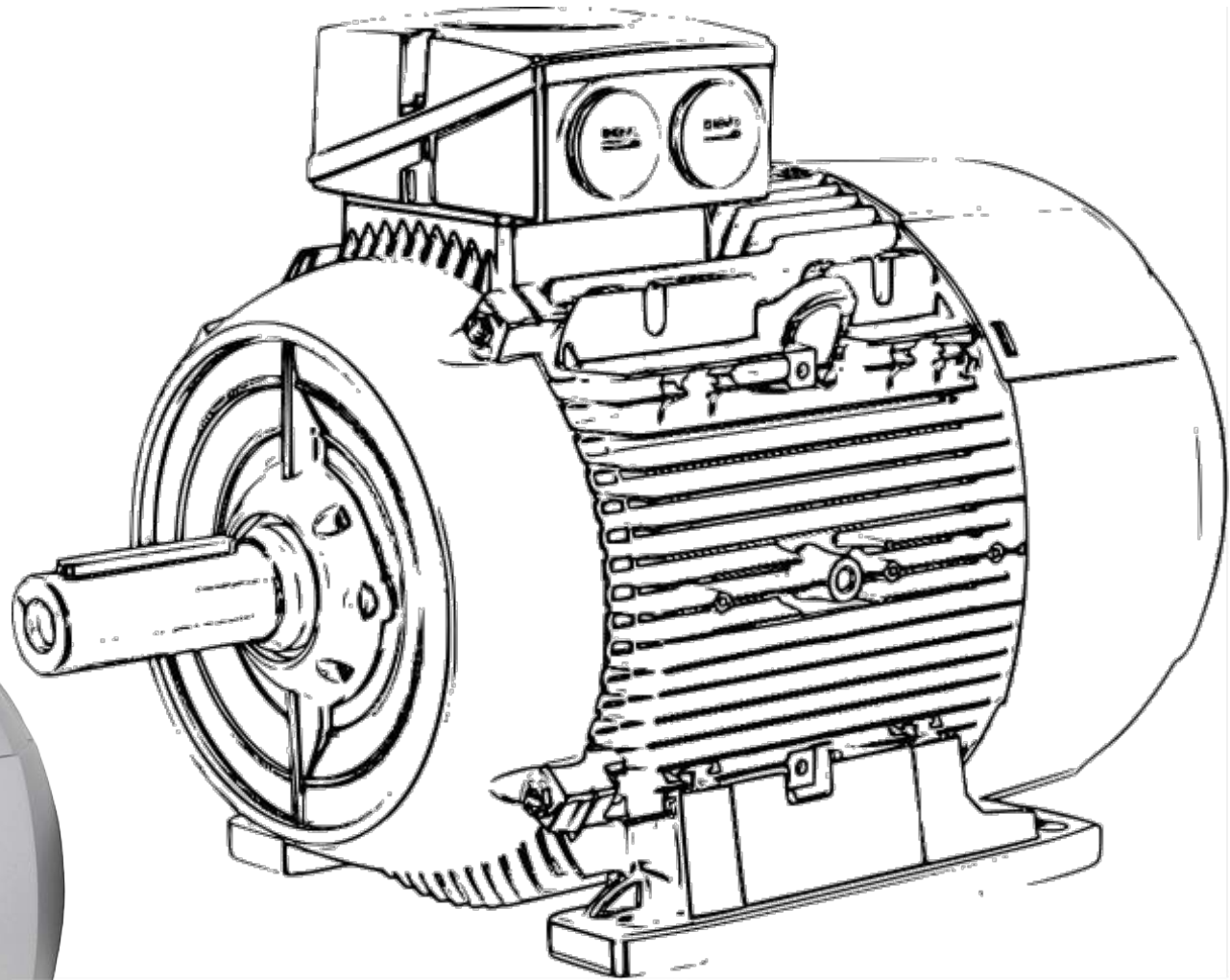

Ciber-física



2000 2002 2004 2006 2008 2010

2000 2002 2004 2006 2008 2010

2000 2002 2004 2006 2008 2010

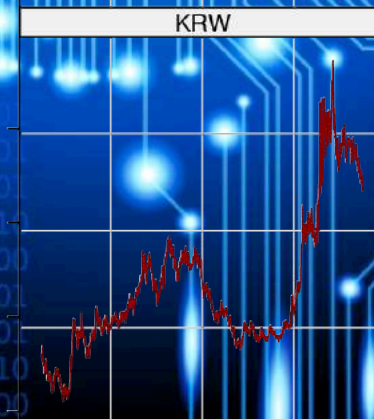
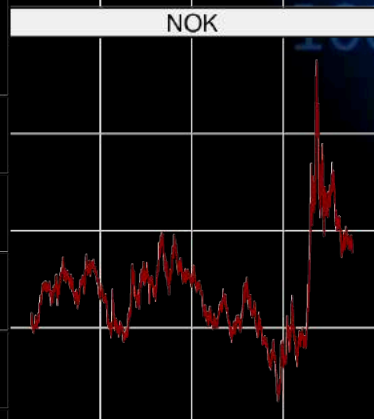
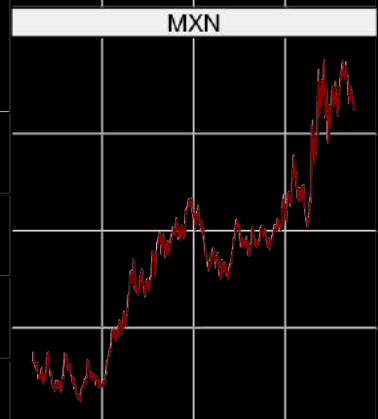
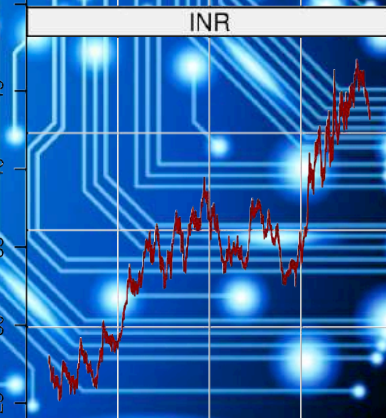
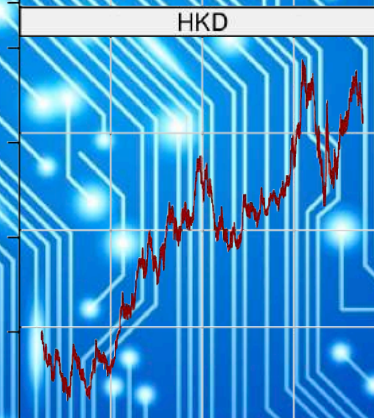
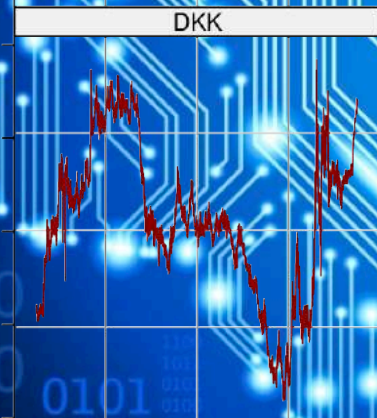
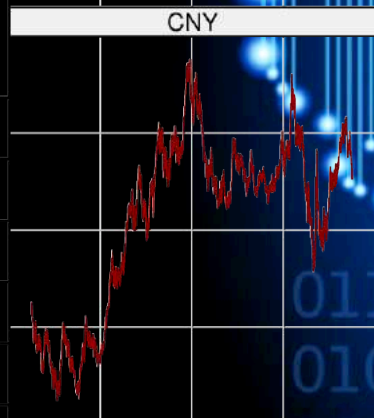
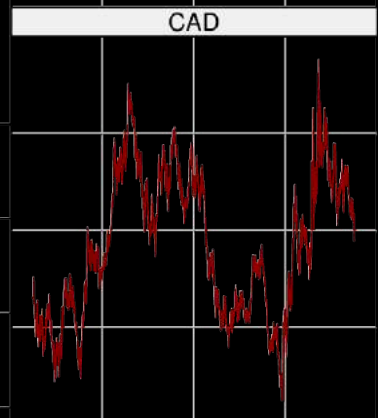
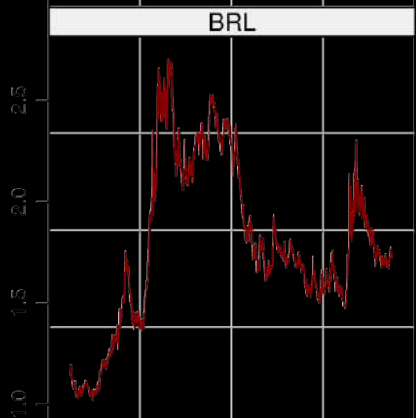
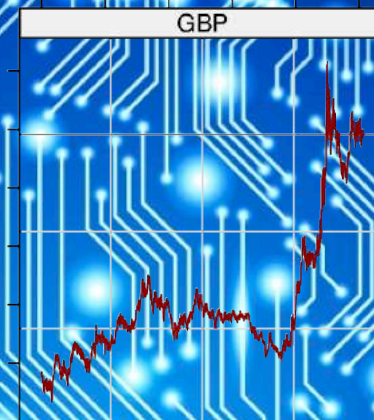
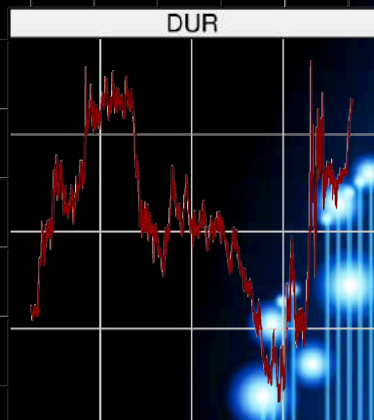
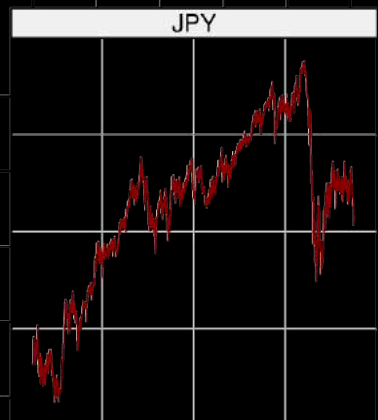
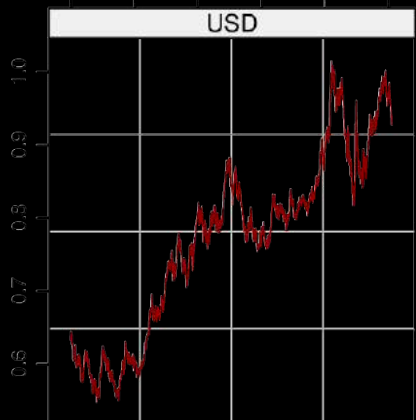

2000 2002 2004 2006 2008 2010

2000 2002 2004 2006 2008 2010

2000 2002 2004 2006 2008 2010

2000 2002 2004 2006 2008 2010

Time



**Integração**

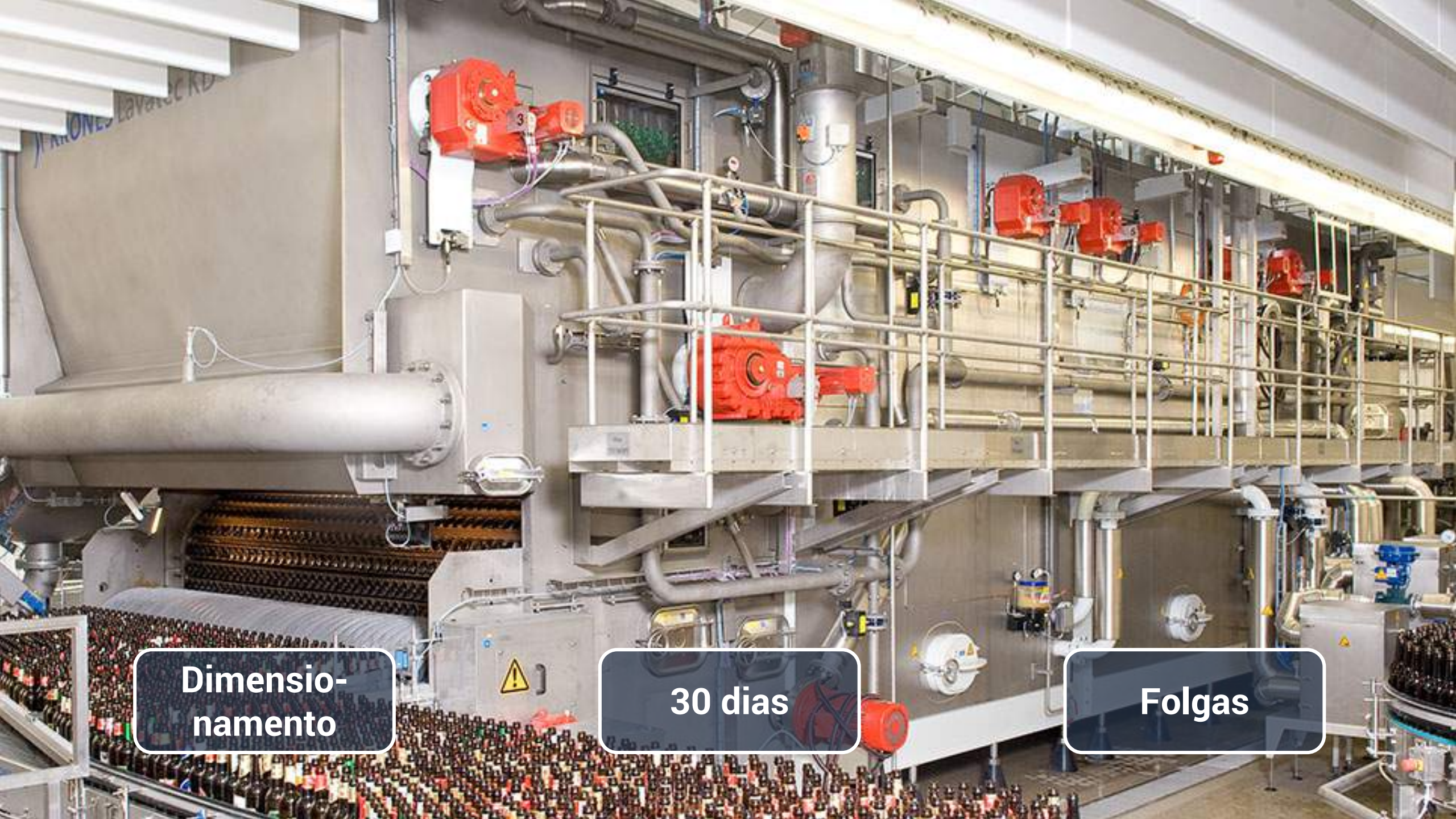

**Dimensio-  
namento**

**30 dias**

**Folgas**



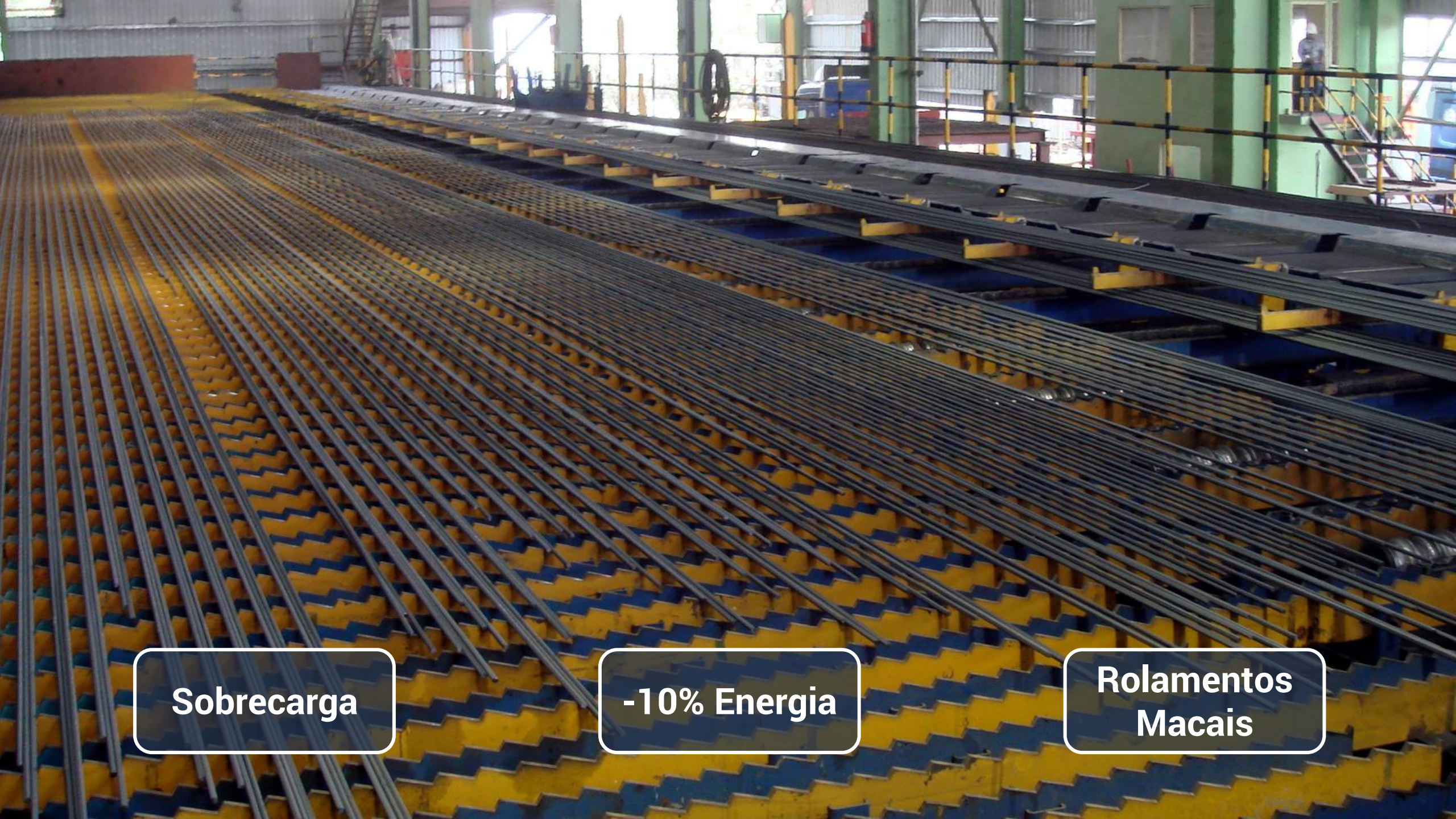

**Sobrecarga**

**-10% Energia**

**Rolamentos  
Macais**

**OBRIGADO!**

**João**

**Marinheiro**



(11) 97072-8099



joao.marinheiro@virturian.com



virturian.com